



Ceiling & Floor Systems

www.speedlinedrywall.co.uk

REVISED
04/2024

Ceiling & Floor Systems

INTRODUCING CEILING & FLOOR SYSTEMS

Speedline offers a full range of metal frame ceiling & floor systems for use in commercial, education, health & domestic situations. The following section provides details of system performance as well as best practice construction guidance. Changes to components and construction details may effect the stated performances.

Contact the Speedline technical team for advice and support on your project:

enquiries@speedlinedrywall.co.uk

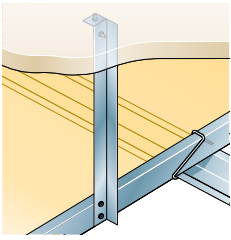

CEILING & FLOOR SYSTEMS

SPEEDLINE MF CEILING SYSTEMS

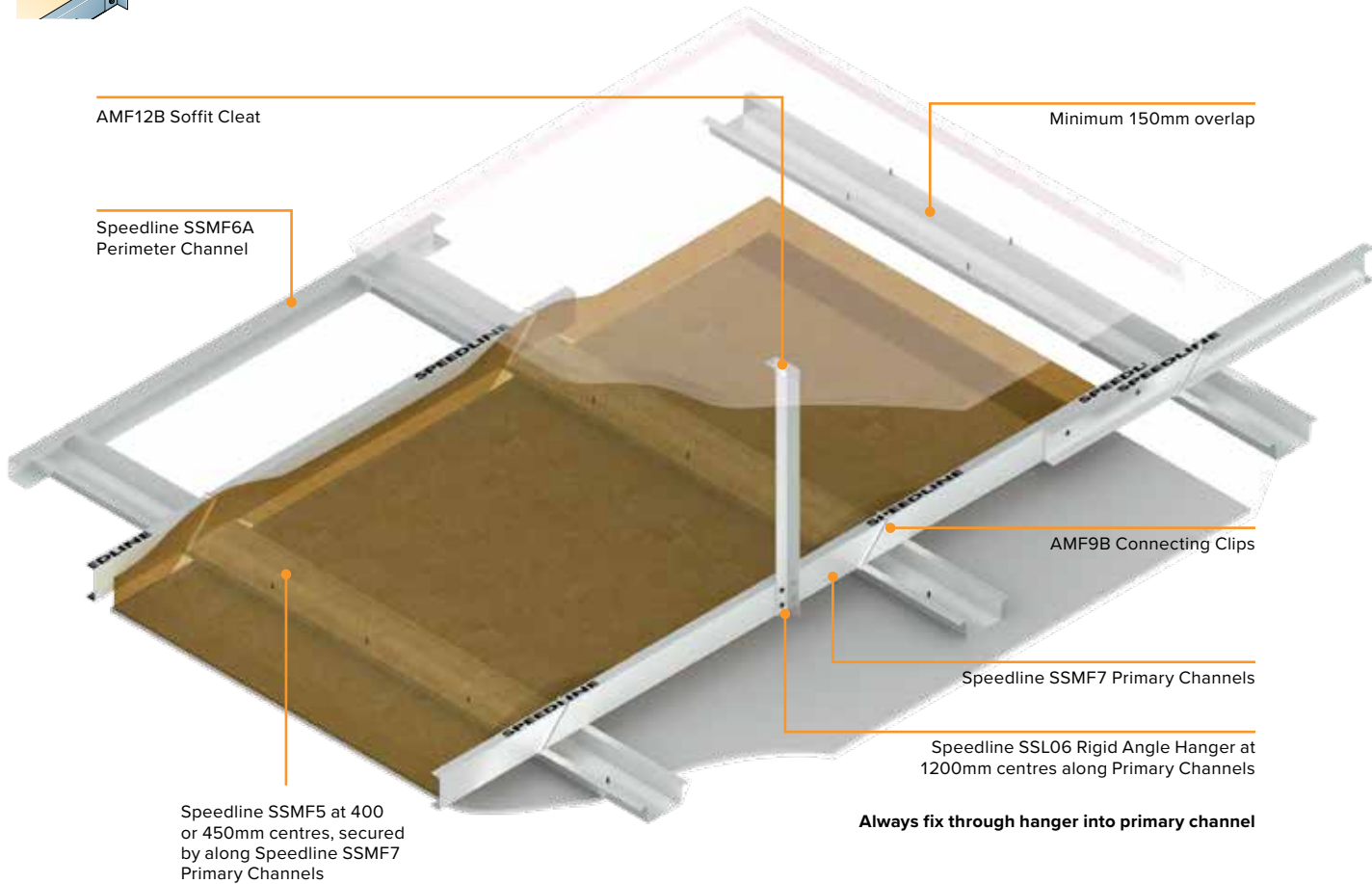

Speedline MF Suspended Ceiling System is ideal for commercial and domestic applications, where services are to be incorporated, or when upgrading and protecting existing structures. Plenum depth is fully variable and dependent on plasterboard type used, excellent levels of sound insulation and fire resistance can be achieved.

Always suspend heavy loads, air ducting, lighting units, etc. directly from structural soffit to prevent point loading of the ceiling system. Speedline also recommend that when using AMF9B connecting clips they are alternated along primary channels.

Benefits

- Easy to cut to length using tin snips.
- Mineral wool can be incorporated for thermal or acoustic insulation.
- Creates a seamless surface suitable to receive most decorative finishes.
- Fits easily together.
- Suitable for fixing all types of plasterboard.
- Creates void above the ceiling for services.
- Improved acoustic performances can be achieved by using Acoustic Hangers.

Sectors

- Residential
- Healthcare
- Education
- Commercial
- Offices
- Retail
- RMI
- Student Accommodation

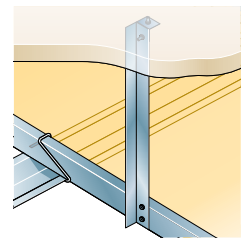

SSMF5 50mm Ceiling Furring

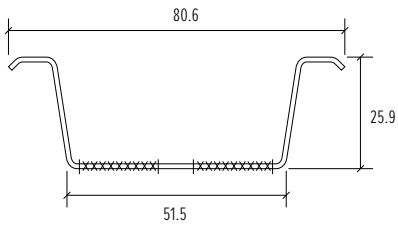

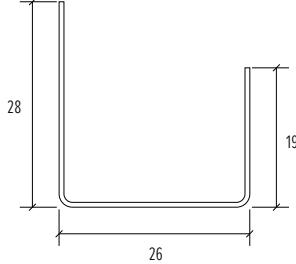

SSMF6A / SSMF7 Perimeter Channel

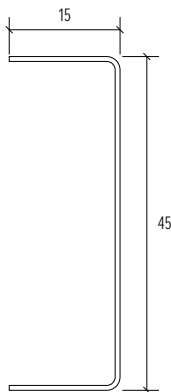

SSMF7 Primary Channel







METAL FURRING SYSTEM

	Product Code	Product Description	Nominal Gauge (mm)	Stock Lengths (Metre)	Weight per Length (Kgs)
	SSMF5	Speedline 50mm Ceiling Furring	0.5	3.60	1.72
	SSMF6A	Speedline Perimeter Channel	0.5	3.60	0.98
	SSMF7	Speedline Primary Channel	0.7	3.60	1.38

METAL FURRING SYSTEM ANGLE

	Product Code	Product Description	Stock Lengths (Metre)	Weight per Length (Kgs)
	SSL06	Angle 25 x 25 x 0.8m 90° Angle	3.60	0.89

METAL FURRING SYSTEM ACCESSORIES

	Product Code	Product Description	Qty per Box	Weight per Box (Kgs)
	AMF9B	Pre-formed Clips	200	2.00
	AMF12B	Angle Fixing Bracket	1000	9.00
	AAH01B	Acoustic Hanger 35mm	100	6.00
	AAH02B	Acoustic Hanger 70mm	100	7.00

SPEEDLINE MF CEILING SYSTEMS

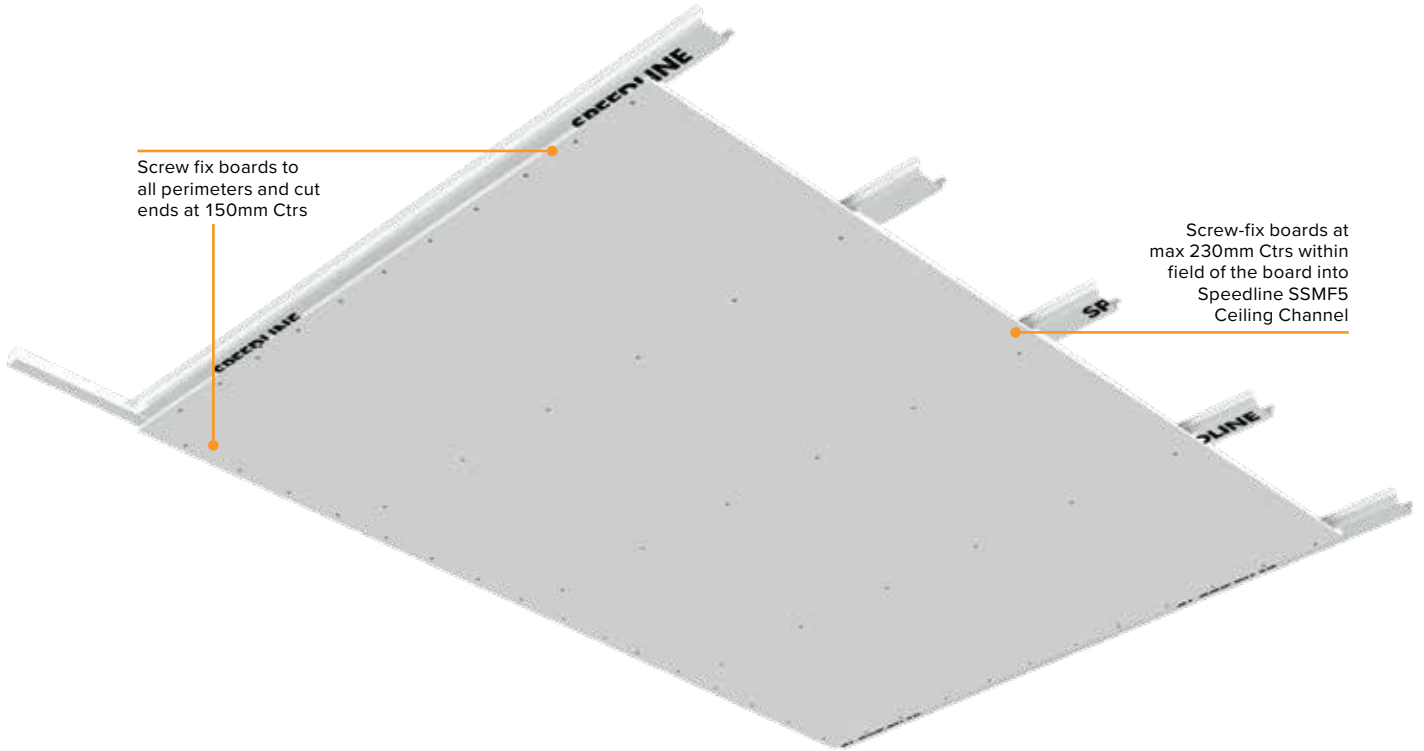
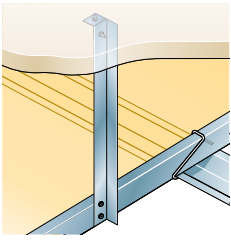

Fixing Plasterboard

When fixing plasterboard onto Speedline MF Ceiling systems, the long bound edge should be positioned at right angles to the Speedline Ceiling Channels. Plasterboard joints should be staggered by half a board length whilst end joints must occur within the centre of the ceiling channel. All joints should be lightly butted together leaving a gap no greater than 3mm. For double layer systems, ensure all joints on the outer layer are staggered in relation to the inner layer. Plasterboard should be fixed with the appropriate length of Speedline Drywall Screws at 150mm centres to all perimeters and cut ends and 230mm centres within the field of the board.

Ceiling Perimeter

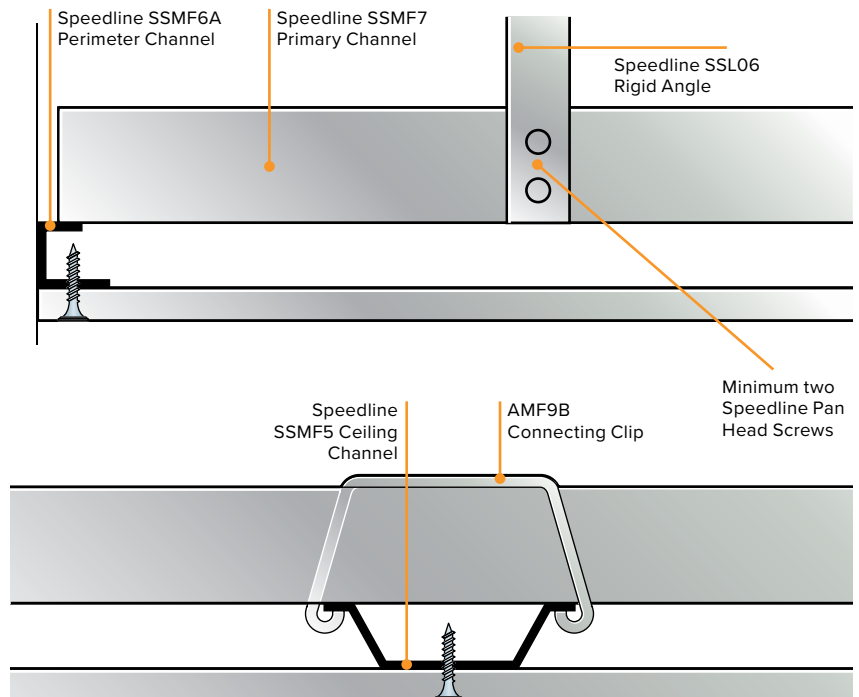

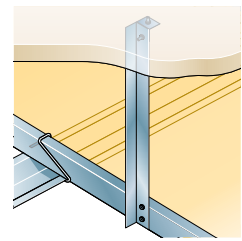

Acoustic Sealant

Seal any air gaps at junctions of linings with walls, floors, ceilings and around openings with a continuous bead of Speedline Intumescent Sealant to clean, dry and dust-free surfaces leaving no air gaps.

MF Ceiling Installations

MF Ceiling Systems are typically used within the residential sector, primarily in apartments. When they are installed in small rooms with low ceiling voids particularly where rooms have been well sealed and are airtight - in a minority of cases, movement of the metal components in the ceiling has caused unacceptable noise, typically when doors are opened and closed.

To overcome this problem, in all domestic situations we recommend that Speedline SSMF5 Ceiling Channel is fitted onto Speedline SSMF7 Primary Channel using two Speedline Drywall Pan Head Screws at each connection.

Fire Resistance

Speedline MF Ceiling System has been tested at the Building Research Establishment to BS 476; part 23:1987. The tests were conducted under steel beams that supported pre-cast concrete slabs and the tests used various densities and brands of fire resistant wallboards.

Report References:

BRE Test Reference 211722 2003

60mins with 1 x 12.5mm Siniat GTEC Fire Board

BRE Test Reference 236863 2007

60mins with 2 x 12.5mm Knauf Fire Panel

BRE Test Reference 236868 2007

60mins with 1 x 12.5mm British Gypsum Gyproc Fireline

Please contact enquiries@speedlinedrywall.co.uk for further assistance.

A further test has also been conducted to EN 1365-2:2000 under a loaded timber floor using 2 layers of 12.5mm British Gypsum Gyproc Fireline with minimum board mass of 10kg/m². The result achieved in test reference 224468 is 88 minutes duration of effective protection.

Sound Insulation

Speedline MF Ceiling System offers excellent acoustic performance for airborne sound (R_w) and impact (L_{nw}) and will improve the sound insulation of both timber and concrete floors. Results are variable and mainly dependent on the depth of the ceiling void and the type of structure to which the system is fixed.

Acoustic Hangers

The important factors in maximising the improvements are cavity depth, insulation and acoustic hangers. Considerable sound improvement can be achieved by suspending an MF System using acoustic hangers - 35mm (232922) or 70mm (232929) which de-couple the ceiling from the structural soffit.

Joining Speedline Components

To join Speedline SSMF5 Ceiling Channels overlap by at least 150mm and secure to both sides with suitable fixings. To join Speedline SSMF7 Primary Channels overlap back to back by at least 150mm and secure with two nuts and bolts. See details below.

Speedline Primary Channel Joint



Speedline Ceiling Channel Joint



SPEEDLINE MF CEILING SYSTEMS

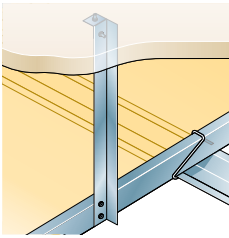

When fixing Speedline SSL06 Angle direct to the soffit without the use of AMF12B Angle Fixing Brackets, the angle can be cut and folded inwards to provide an alternative fixing detail (see detail below). A suitable fixing should pass through both legs of the angle into the structural soffit. When using this method the imposed load the system can support is reduced by 25% - refer to imposed load table below.

E.g. a 1200 x 1200 grid new safe working load is 23kg/m², therefore could not support a double layer of sound resistant plasterboard without reducing your Speedline SSMF7 Primary Channels to a maximum of 900mm centres.

Partition Head

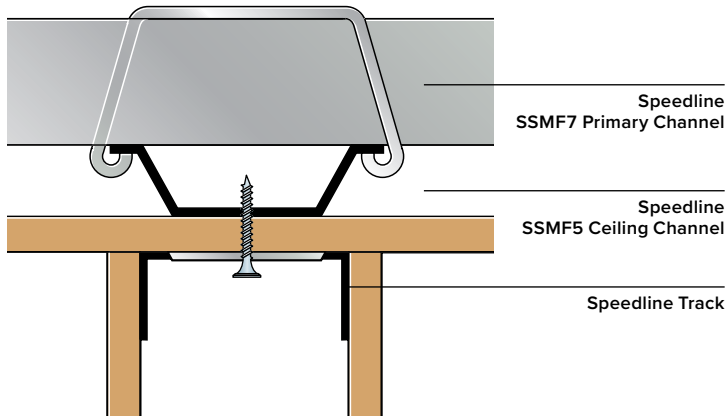

Detail

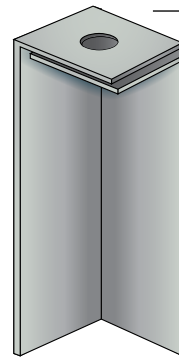

Both legs of angle bent inward to form double thickness fixing face. We also suggest the use of a washer.

Imposed Loads

The Speedline MF Ceiling System can support the following imposed loads.

Suspension point centres (mm)	SMF7 Primary Channel centres (mm)	Maximum load including weight of board if using angle cleats (up to kg/m ²)	Max load fixing angle direct to soffit with approved detail (kg/m ²)
1200	1200	30	22
1200	900	40	30
1200	600	60	45

SPEEDLINE MF CEILING SYSTEMS

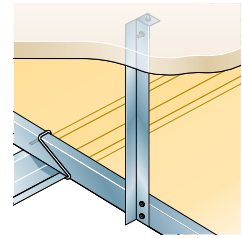

MF CEILING SYSTEM

GENERAL LAYOUT

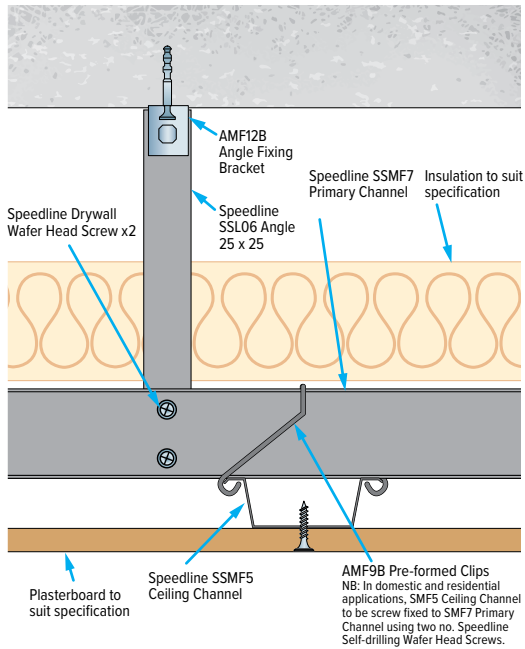

MF CEILING SYSTEM

CEILING TO WALL ABUTMENT

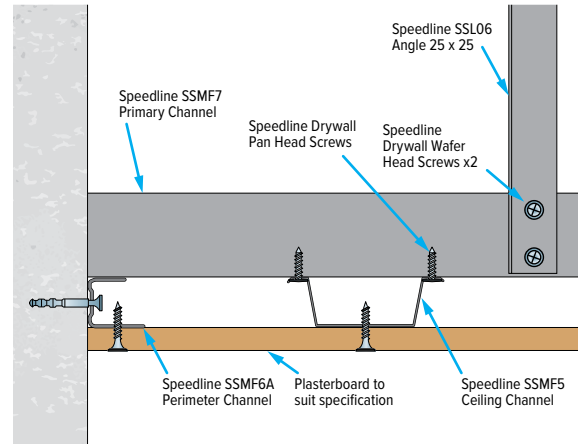

MF CEILING SYSTEM

CHANGE OF LEVEL

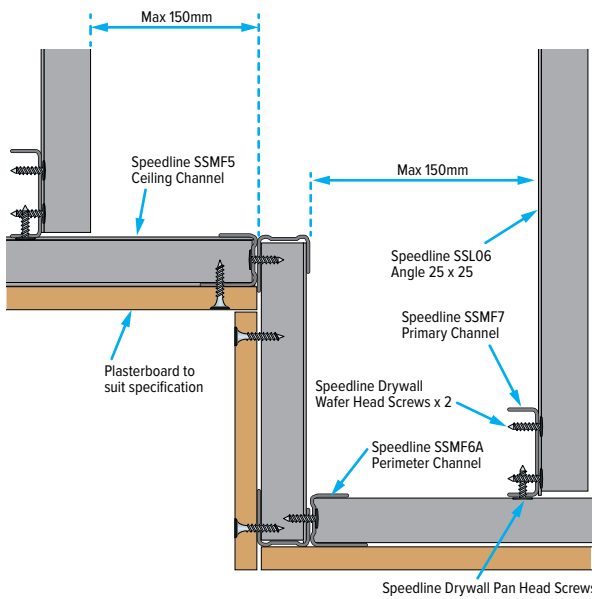

MF CEILING SYSTEM

BULKHEAD

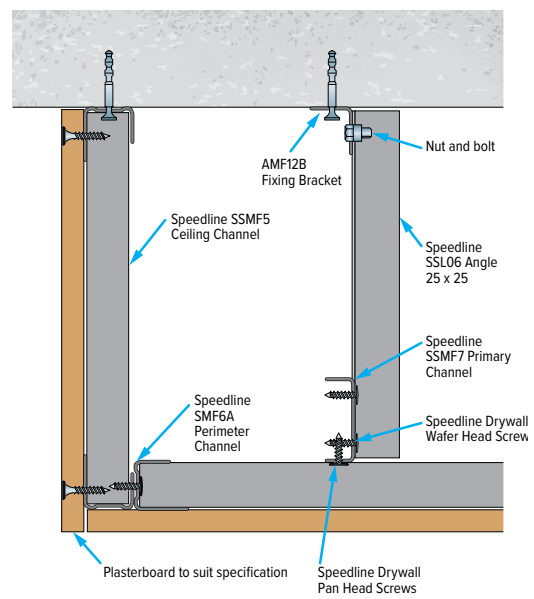

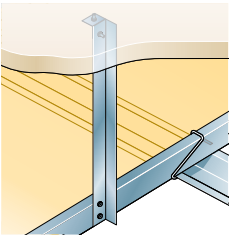

CEILING & FLOOR SYSTEMS

SPEEDLINE CEILING LINER SYSTEMS

Suitable for Concrete and Timber Floors

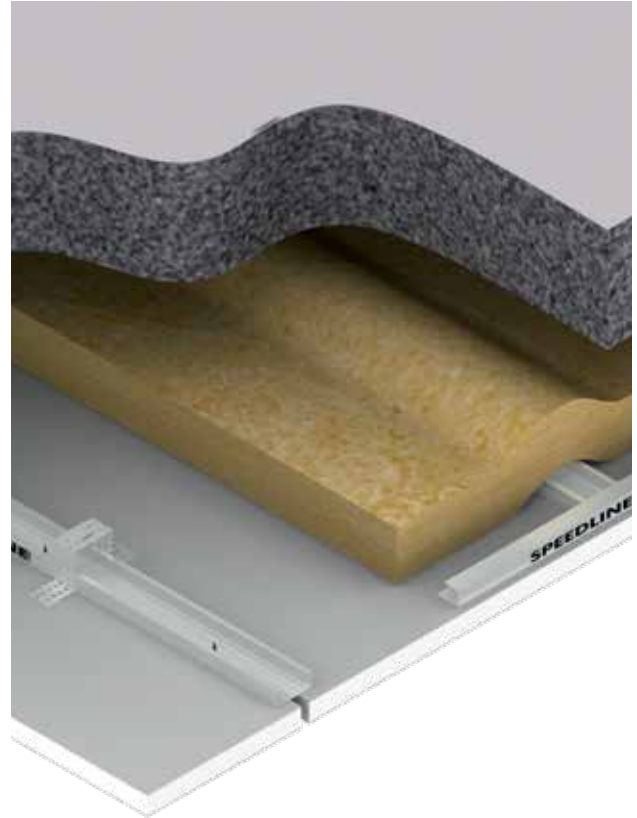
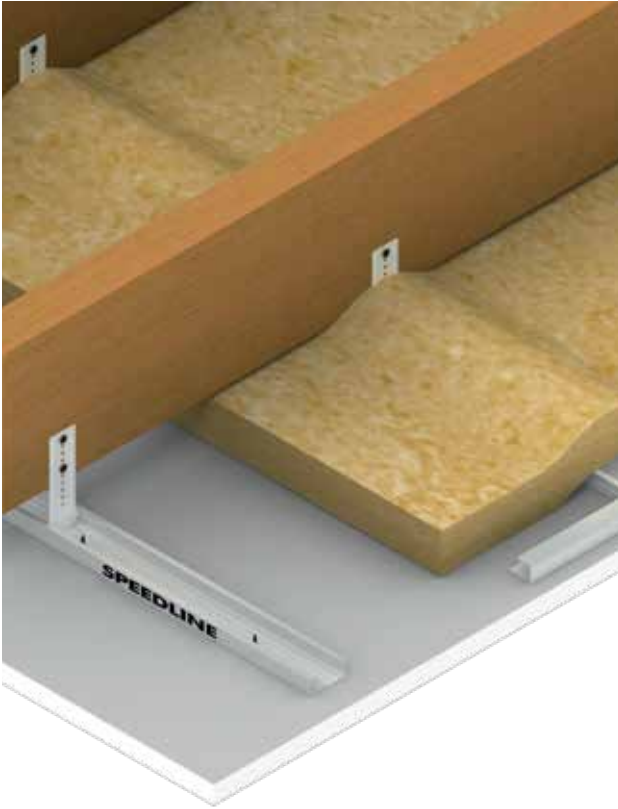

Often used in commercial and domestic situations and suited to both new-build and refurbishment projects. The Speedline Ceiling Lining System is suitable for most internal applications

It can be used under timber or concrete flooring with any proprietary gypsum plasterboard. Insulation can be incorporated within the ceiling cavity for improved acoustic performance.

Construction

Fix Speedline SWL60 to the perimeter of the room at maximum 600mm centres with the longer leg facing the bottom. Install AWL03B, AWL04B or AWL08B Brackets at maximum 900mm centres with suitable fixings. Locate Speedline SWL507 Ceiling Liner at 400mm or 450mm centres into perimeter channel and brackets, secure each leg of the bracket into the ceiling liner with Speedline Drywall Wafer Head Screws. See Metal Framing Centres and Fixing Bracket/Timber Connector Centres on page 122.

Position fixing brackets - AWL03B (75mm leg), AWL04B (125mm leg) or AWL08B (175mm leg) - to timber joists or concrete. For large areas of ceiling use connector AWL05B to join the Ceiling Liner SWL507 together.

Timber connectors are also available, reference AWL06 (55mm leg) and AWL07 (155mm leg) which allow fixing to the side of timber joists - see page 122.

Fix plasterboards with long edges at right angles to Speedline SWL507 Ceiling Liner and fix to framing with the appropriate length of Speedline Drywall Screw at 230mm maximum centres within the field of the board and at 150mm centres on cut edges and to all perimeters. For double layer systems, ensure all joints on the outer layer are staggered in relation to the inner layer. Outer layer should be fixed at the same centres as previously described.

In addition to improving acoustic performance, Speedline Ceiling Liner Systems can also improve fire resistance dependent on gypsum board type being used. Please contact enquiries@speedlinedrywall.co.uk for further assistance.

Speedline Ceiling Liner Systems also provide a cavity within which services can be routed without the need for drilling of joists.

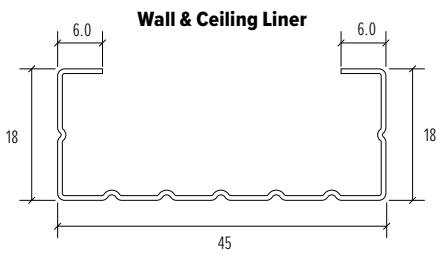
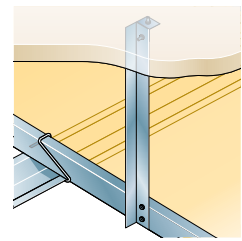

SPEEDLINE CEILING LINER SYSTEMS



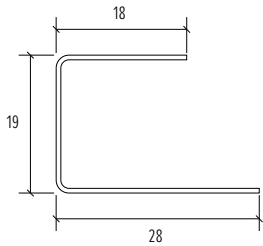



Wall & Ceiling Perimeter Track



CEILING LINER SYSTEM

	Product Code	Product Description	Nominal Gauge (mm)	Stock Lengths (Metre)	Weight per Length (Kgs)
	SWL507	Speedline Wall & Ceiling Liner	0.5	2.40	0.83
				2.70	0.93
				3.00	1.04
				3.60	1.25
	SWL60	Speedline Wall & Ceiling Perimeter Track	0.5	3.00	0.73

ACCESSORIES (CEILING LINER SYSTEM)

	Product Code	Product Description	Qty Per box	Weight per Box (Kgs)
	AWL03B	Fixing Bracket - 75mm leg	100	3.70
	AWL04B	Fixing Bracket - 125mm leg	100	5.60
	AWL08B	Fixing Bracket - 175mm leg	100	7.50
	AWL05B	Wall/Ceiling Liner Connector	50	1.35
	AWL06B	Timber Connector	200	5.00
	AWL07B	Timber Connector	100	7.00

Benefits

- Easy to cut to length using tin snips.
- Mineral wool can be incorporated for thermal or acoustic insulation.
- Creates a seamless surface suitable to receive most decorative finishes.
- Fits easily together.
- Suitable for fixing all types of plasterboard.
- Creates void above the ceiling for services.
- Good method to level poor concrete and wooden floors.

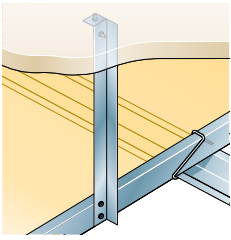

CEILING & FLOOR SYSTEMS

SPEEDLINE CEILING LINER SYSTEMS

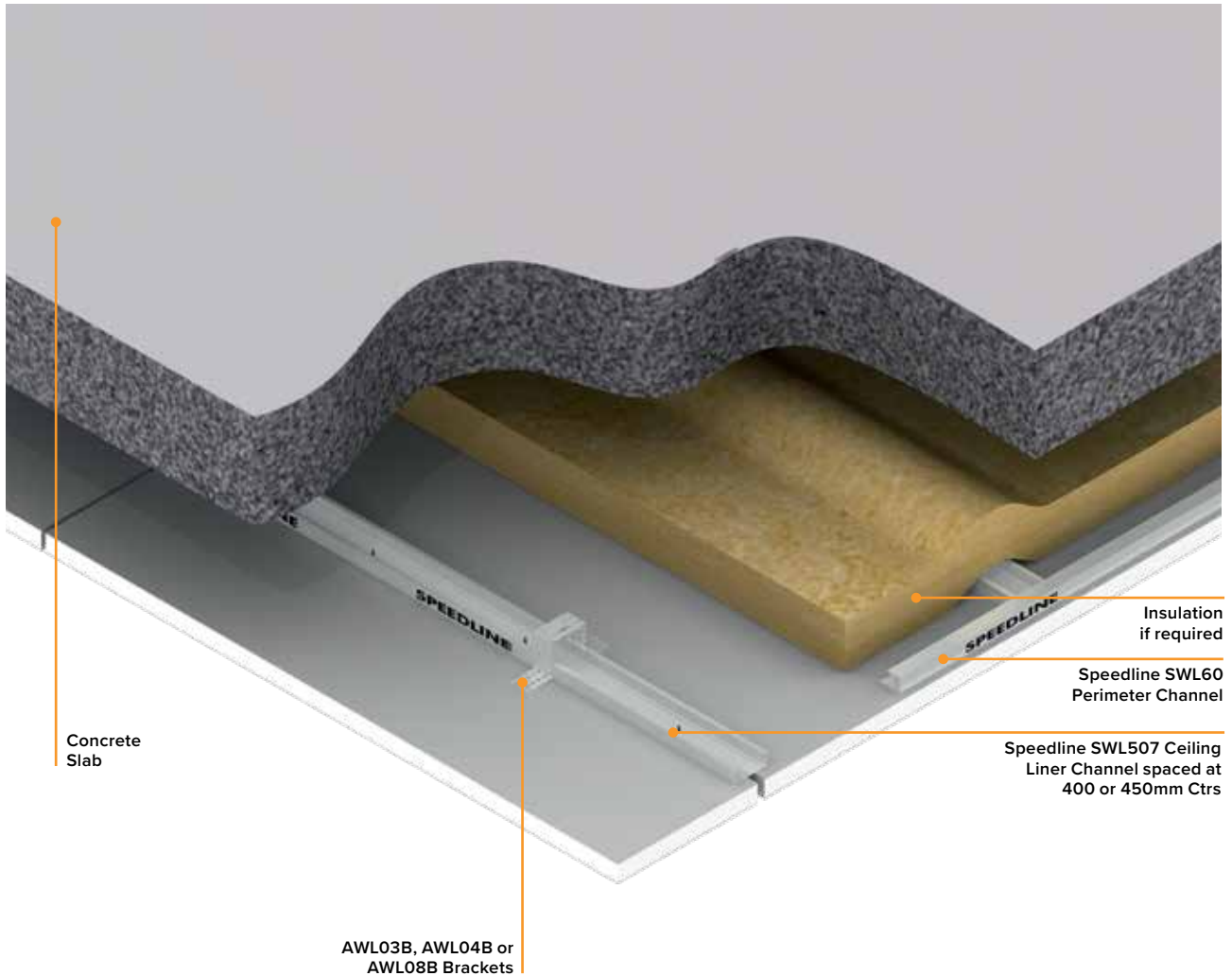

Fire Resistance

The latest test carried out at the Warrington Fire Research Establishment was tested to the European Standard - BS EN 1365-2:2000 - Fire Resistance Tests for Load Bearing Elements/part 2: Floors and Ceilings.

The test was conducted under a wooden floor with weights loaded above, using one layer of Siniat 12.5mm GTEC Fire Board. Minimum board mass must be 10.0kg/m². Result achieved from test number WARRES 114632 is 60 minutes load bearing capacity, integrity and insulation.

Sound Insulation

The Speedline Ceiling Lining System achieves good acoustic performance for both airborne sound (R_w) and impact (L_{nw}).

This system will improve the sound insulation of both timber and concrete floors. Results are variable mainly dependant on the depth of the ceiling void and the type of structure to which the system is fixed.

The important factors in maximising the improvements are:-

- Cavity Depth.
- Cavity Insulation.
- Plasterboard type and density.

SPEEDLINE CEILING LINER SYSTEMS

SOLUTIONS

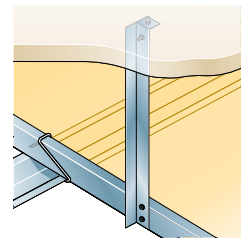

TIMBER FLOORS

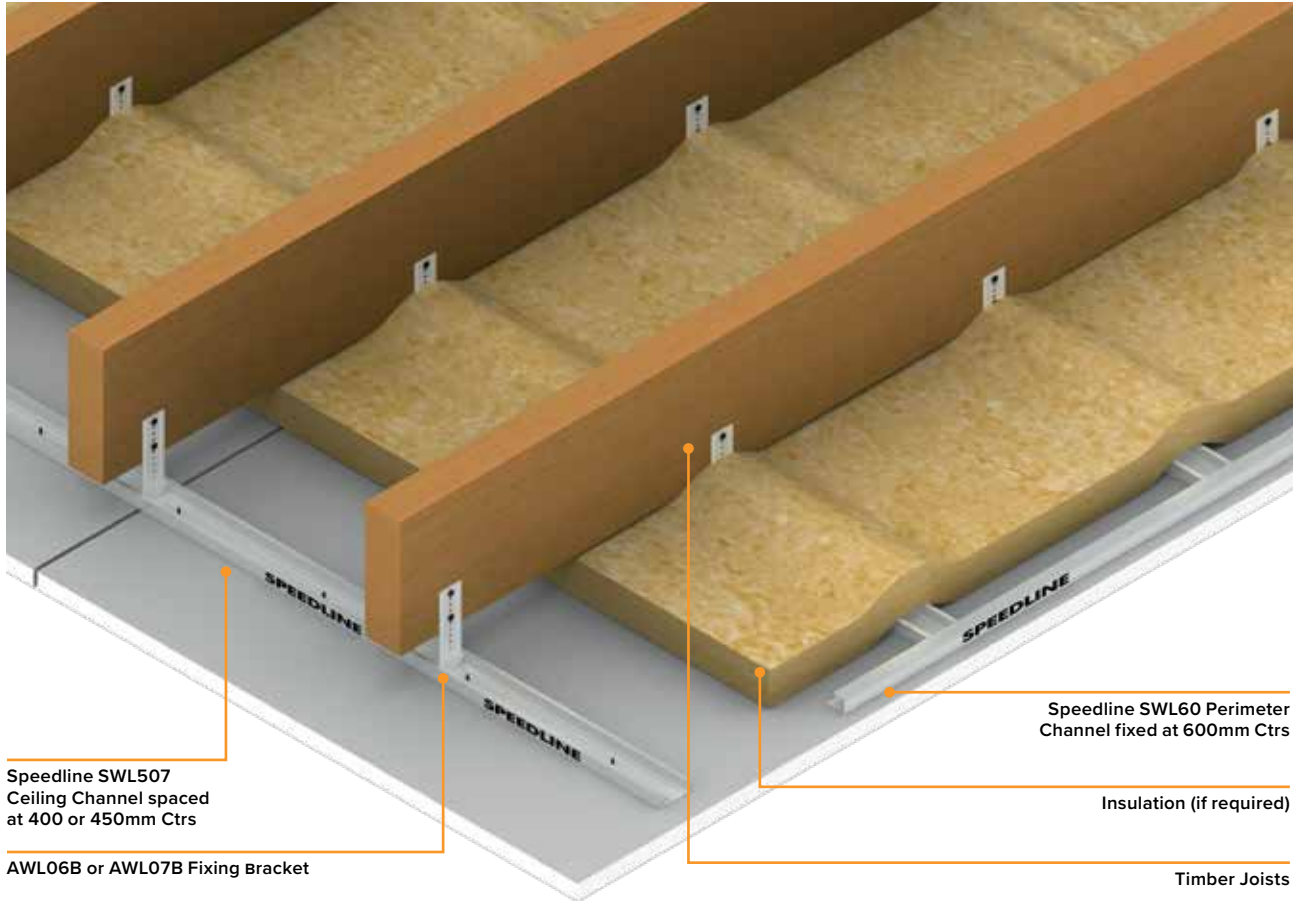

Speedline SWL507 Ceiling Channel spaced at 400 or 450mm Ctrs

AWL06B or AWL07B Fixing Bracket

Speedline SWL60 Perimeter Channel fixed at 600mm Ctrs

Insulation (if required)

Timber Joists

Metal Framing Centres – Quick Reference

Board thickness (mm)	Board Length (m)	Ceiling Liner (SWL507) Ctrs (mm)
12.5mm, 15mm & 19mm	2.4, 3.6	400
	1.8, 2.7, 3.0	450

Fixing Bracket/Timber Connector Centres – Quick Reference

Board Thickness	Maximum (mm)
9.5mm plasterboard single layer	900
12.5mm plasterboard single layer	900
15mm plasterboard single layer	900
All double layer boarding	600

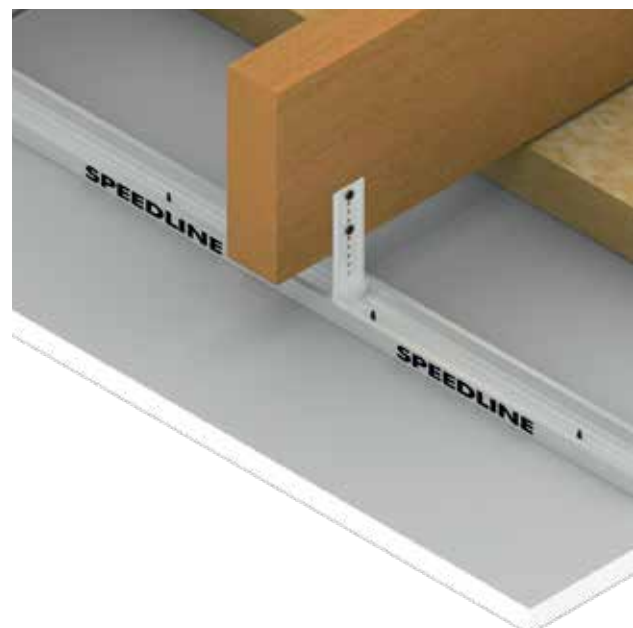

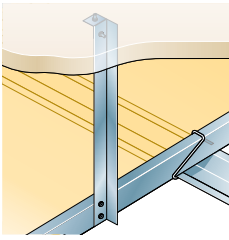

CEILING & FLOOR SYSTEMS

SPEEDLINE RESILIENT BAR CEILING SYSTEMS

Timber Joists

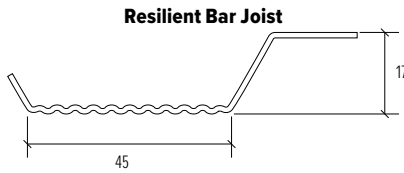

The Speedline RB565 Resilient Bar Joist is designed to provide improved sound insulation when constructing a conventional ceiling under timber joists.

Mineral wool insulation can also be included in the floor cavity to improve acoustic performance. To ensure maximum sound insulation performance, screws fixing the plasterboard must not be in contact with the joists.

Speedline RB565 Resilient Bar Joist is fixed to the underside of joists at 400mm or 450mm centres depending on board length with 36mm Speedline Drywall Coarse Thread Screws, additional resilient bar noggins are required around the perimeter of the ceiling. Resilient bars are joined by butting together under the timber joist.

Position plasterboards at right angles to the resilient bars and fix at 230mm centres within the field of the board and at 150mm centres on cut edges and to all perimeters using the appropriate length Speedline Drywall Screw. For double layer systems, ensure all joints on the outer layer are staggered in relation to the inner layer. Outer layer should be fixed at the same centres as previously described.

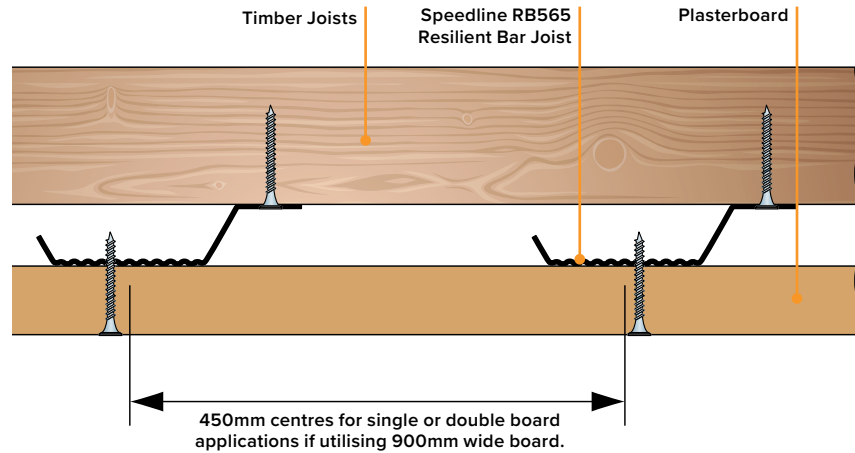

RESILIENT BAR JOIST

	Product Code	Product Description	Nominal Gauge (mm)	Stock Lengths (Metre)	Weight per Length (Kgs)
	RB565	Speedline Resilient Bar Joist	0.5	3.00	1.04

The following were tested as floor applications under timber beams 235mm x 50mm spaced at 450mm centres with 15mm OSB fixed to the top of the joists.

Each ceiling was boarded with an inner layer of 19mm standard plasterboard (plank) and an outer layer of 12.5mm sound resistant wallboard. 100mm glass mineral wool was infilled into the joist cavities.

	Boards fixed direct to timber beams in the conventional method	Boards fixed to our Resilient Bar (RB565) spaced at 400mm centres
Airborne R_w dB	40	54
Impact L_{nw}	74	61
Airborne $R_w + C_{tr}$	33	45

Recommendations for maximum loadings for Resilient Bars

Centres (mm)	Uniformed distributed load (kg/m ²)
400	35
450	30

CEILINGS & FLOOR SYSTEMS

SPEEDLINE RESILIENT BAR CEILING SYSTEMS

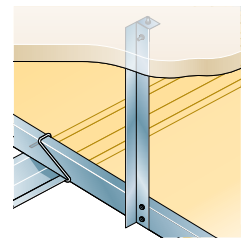

**ACOUSTIC
FLOATING FLOORS**

Floating floor

Floor decking

Joists

Absorbent material

Ceiling

Speedline Resilient Bar Joist

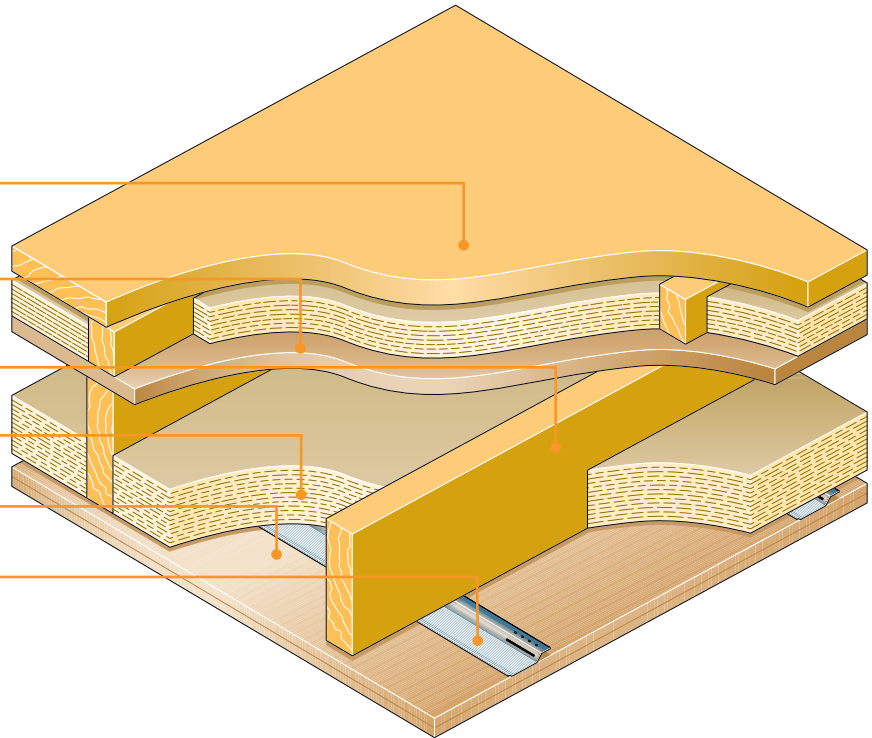

Speedline RB565 Resilient Bar Joist

Is now fully approved within the following Robust Detail Separating Floors, solutions:

- Concrete E-FC-1.
- Timber I – Joists E-FT-1.
- Timber Solid Joists E-FT-2.
- Metal Web Joists E-FT-3.
- Timber I Joists E-FT-4.
- Timber I Joists E-FT-5.
- Beam Metal Joists E-FS-2.

The Robust Detail acoustic test criteria has been undertaken at the Sound Research Laboratories in Suffolk, report number C/09/5L/20805/R01 refers.

Laboratory Test Construction of Floor with Direct Fix Ceiling



Laboratory Test Construction of Floor with the Ceiling Connected via Resilient Bars

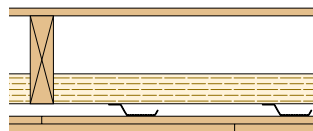

For resilient bars to be approved for use in Robust Detail separating floors they must be tested as detailed in Appendix E of the Robust Details Handbook. The testing procedure consists of testing a standard floor construction without resilient bars and then testing the same standard floor with the addition of resilient bars installed between the floor joists and the plasterboard ceiling. Both airborne sound and impact sound tests are carried out on both floor constructions.

The required minimum improvements for the floor with resilient bars attached compared to the floor without resilient bars is 17 dB improvement in airborne sound insulation ($R_w + C_{tr}$) and 16 dB improvement in impact sound insulation (L_w). The Speedline RB565 resilient bar joist has achieved these minimum standards.

Speedline RB565 resilient bar joist can be used in Robust Detail separating floors without the need for on-site acoustic testing.

Data Sheet 3

Test Number: 5
Client: Metsec
Test Date: 23/06/2009
Sample length: 3.985 m
Sample width: 2.715 m
Product:
Identification: Timber base floor as per Robust Detail Appendix E with RB565 resilient bars installed at 400mm centres

Air temperature: 21.1 °C
Air humidity: 64%
Receiving room volume: 55 m³
Source room volume: 50 m³
Sample weight: 38.1 kg/m²

Freq f Hz	Sound Reduction Index, dB	
	1/3 Oct	1/1 Oct
50+	32.6	
63+	20.5	24.5
80+	29.7	
100	36.5	
125	40.4	38.2
160	38.6	
200	42.4	
250	47.4	45.3
315	49.3	
400	51.7	
500	52.4	52.7
630	54.3	
800	56.9	
1000	58.6	58.1
1250	59.1	
1600	59.0	
2000	59.4	60.0
2500	62.2	
3150	63.0	
4000	66.8	65.7
5000	70.2*	
6300+	74.0*	
8000+	75.3*	74.3
10000+	73.7*	
Average 100-3150	52.0	

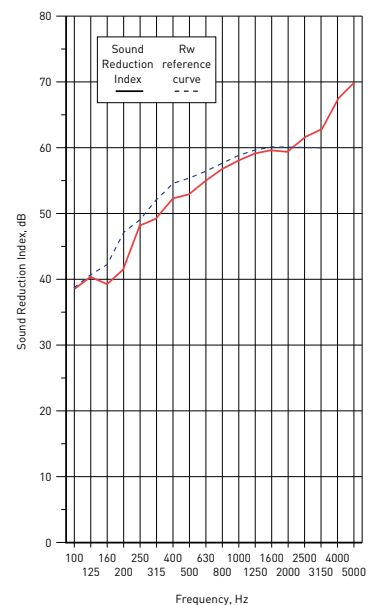

Rating according to BS EN ISO 717-1:1997
R_w(C;Ctr) = 56 (-2;-6) dB

Notes * designates measurement corrected for background
 # designates limit of measurement due to background
 + designates frequency beyond standard and not UKAS accredited

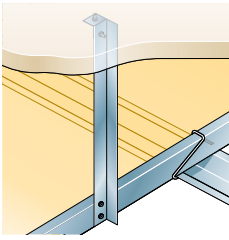

CEILINGS & FLOOR SYSTEMS

SPEEDLINE SEPARATING FLOOR SYSTEM

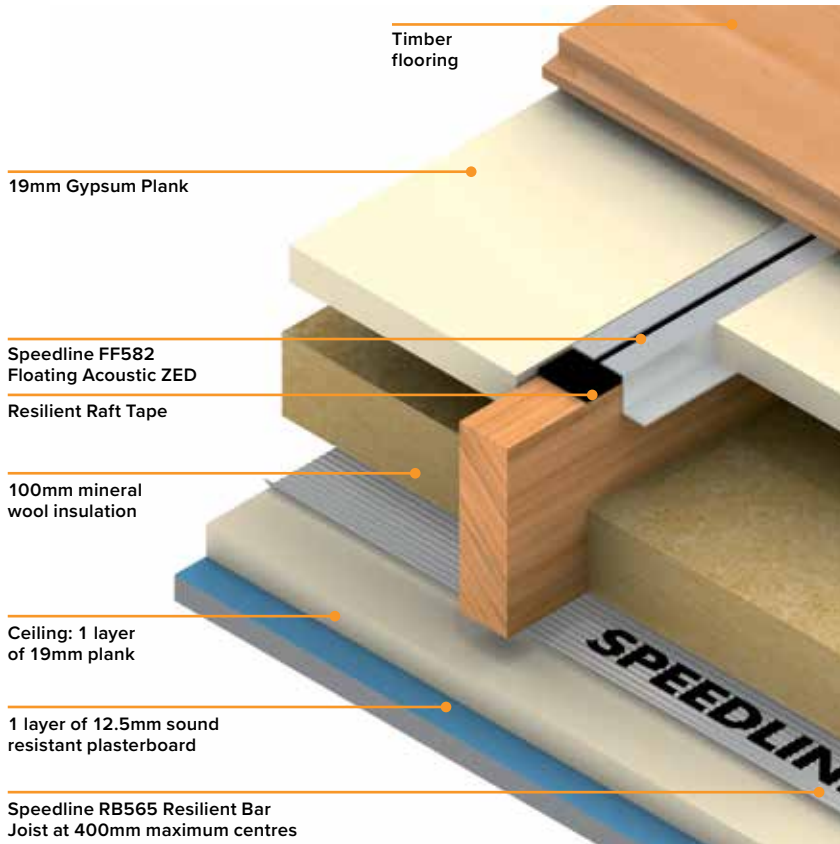

Benefits

- Minimal increase in floor depth.
- Ideal for conversion work & refurbishment.
- Suitable for any size timber joist.
- Floor floats independent of original structure.
- Fast and simple to fit.

The Speedline Floating Floor System offers excellent acoustic improvement for both airborne and impact sound transfer.

This system is ideal for residential conversions and refurbishments of older properties to upgrade existing timber floors. It can also be used to improve sound insulation from upper floors in new build projects.

Sectors

- Residential – change of use from House to separate Apartments.

Construction

Flooring

Fit self adhesive resilient raft tape along the length of each joist.

On top of the resilient raft tape place a floating acoustic ZED each side of the joist with the large flange on top of the joist. For smaller joists it may be necessary to overlap the flanges of the floating acoustic ZED sections. On larger joists there can be a gap between the sections. See details below. To help installation it may be necessary to temporarily secure the floating acoustic ZED sections into place using screws. The screws should be removed prior to installing the floor surface to ensure optimum performance.

19mm plank is cut neat (not tight) to fit between the floating acoustic ZED sections. The next board should be butted tightly to the previous board.

The timber flooring is then laid across the top at 90° to the floating acoustic ZED sections and screw fixed through the plank and into the bottom flange of the floating acoustic ZED section using suitable screws. It is important to ensure that any temporary screws are removed from the floating acoustic ZED sections before fitting the timber flooring and that no fixings are allowed to connect the floating acoustic zed section to the timber joist through the timber flooring.

A 5mm clearance gap must be left at perimeter walls which must be fully filled with Speedline Intumescent Sealant.

By following this procedure a completely free floating floor has been created.

Small joist

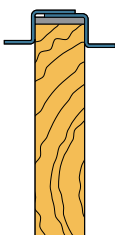

Large joist

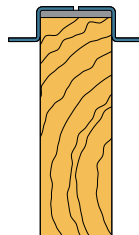

Perimeter joist

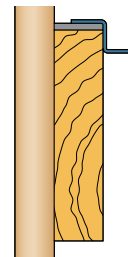

SPEEDLINE SEPARATING FLOOR SYSTEM

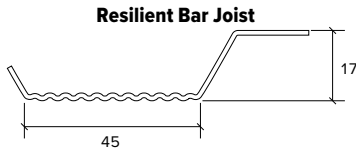
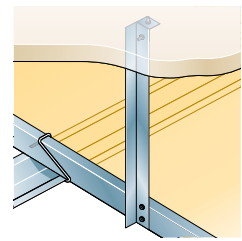

RESILIENT BAR JOIST

	Product Code	Product Description	Nominal Gauge (mm)	Stock Lengths (Metre)	Weight per Length (Kgs)
	RB565	Speedline Resilient Bar Joist	0.5	3.00	1.04

Ceilings

Speedline RB565 Resilient Bar Joist is fixed at right angles to the joists at maximum 450mm centres for single or double board applications.

Bars are joined by butting together under the timber joist. Plasterboards are fixed with long edges at right angles to resilient bars at 230mm centres within the field of the board and at 150mm centres on cut edges and to all perimeters using the appropriate length Speedline Drywall Screw. For double layer systems, ensure all joints on the outer layer are staggered in relation to the inner layer. Outer layer should be fixed at the same centres as previously described.

To achieve maximum sound insulation performance, ensure that none of the board fixings penetrate through the resilient bar and into the timber joists.

The addition of glass mineral wool insulation within the floor cavity will improve the acoustic performance.

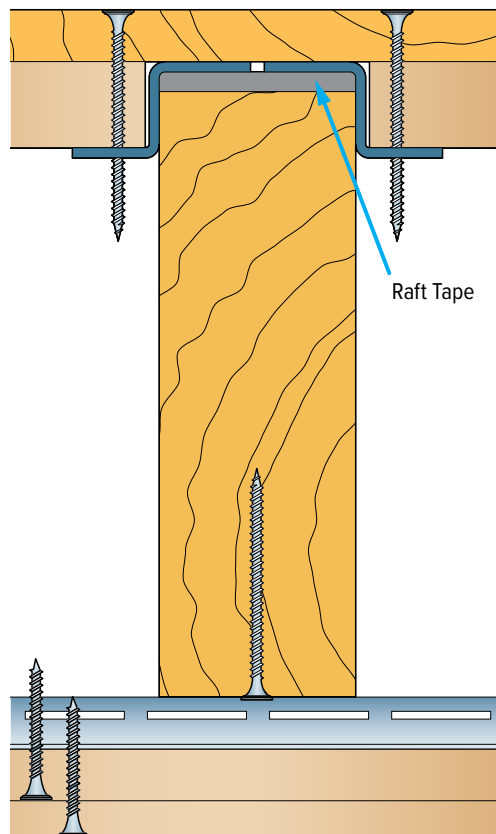

Performance Data

Floor - 19mm plank on our Floor Zed profile FF582 located over joists 235mm x 50mm spaced at 450mm centres clad with 15mm OSB board.

Insulation - 100mm mineral wool in cavity.

Ceiling - Resilient Bar RB565 fitted to underside of joists spaced at 400mm centres clad with 1 inner layer of 19mm plank and 1 outer layer of 12.5mm sound resistant plasterboard.

Fire Resistance

60 minutes

Sound Insulation

Airborne R_w 60dB
Impact L_{nw} 53dB

Speedline Resilient Bar Joist is fully approved for use in Robust Detail Construction in accordance with Appendix E of the Robust Detail Part E Handbook.

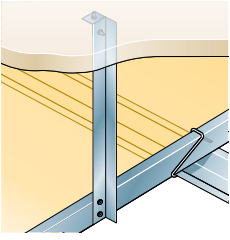

CEILING & FLOOR SYSTEMS
DETAIL

CEILINGS
DETAIL